

Axial-Ventilator for mur eller loft.

31 - 2B
SfB (57)X

CE / IP 55 / 230 Volt eller 400 Volt

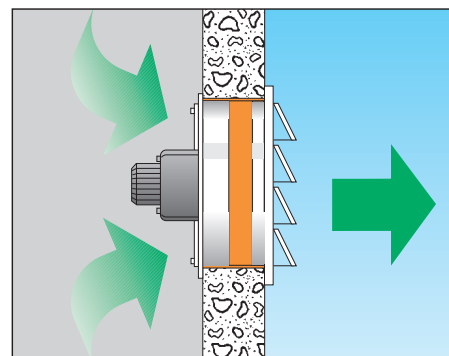
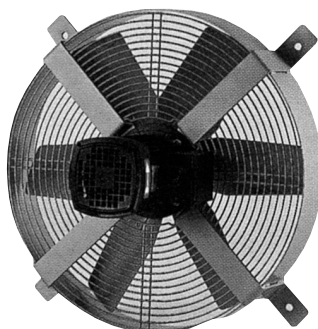
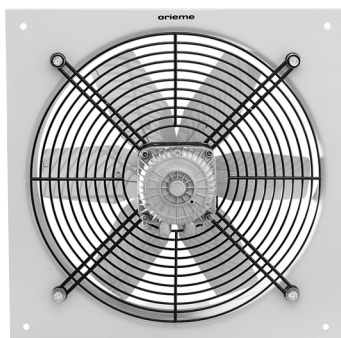

Tekniske data

Data type	Volt 50 Hz	Effekt W	Omdr. o/m	Mål i mm.									Støj dB (A)	Vægt kg.	Max. m ³ /t
				A	B	C	D	E	F	G	H	L			
OIA 254/M□	230	55	1400	320	280	320	280	135	85	272	45	X	51	3,6	1000
OIA 304/M□	230	82	1400	370	330	370	330	140	90	322	47	X	55	4,0	1600
OIA 354/M□	230	135	1400	430	390	430	390	208	150	373	56	X	59	5,2	2500
OIA 404/M□	230	190	1400	500	460	500	460	203	150	420	54	X	62	8,2	3700
OIA 504/M○	230	580	1400	650	590	30	530	X	X	X	110	288	72	14,4	7000
OIA 254/T□	400	52	1400	320	280	320	280	135	85	272	45	X	51	3,6	1000
OIA 304/T□	400	78	1400	370	330	370	330	140	90	322	47	X	55	4,0	1600
OIA 354/T□	400	128	1400	430	390	430	390	208	150	373	56	X	59	5,2	2500
OIA 404/T□	400	175	1400	500	460	500	460	203	150	420	54	X	62	8,2	3700
OIA 504/T○	400	550	1400	650	590	30	530	X	X	X	110	288	72	14,4	7000
OIA 506/T○	400	245	900	650	590	30	530	X	X	X	110	288	61	14,5	4400
OIA 604/T○	400	970	1400	750	690	30	630	X	X	X	145	350	76	23,0	12200
OIA 606/T○	400	620	900	750	690	30	630	X	X	X	145	350	64	21,2	7500
OIA 806/T○	400	1650	900	950	890	30	833	X	X	X	170	455	75	47,0	19800

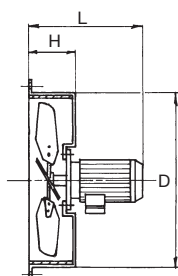
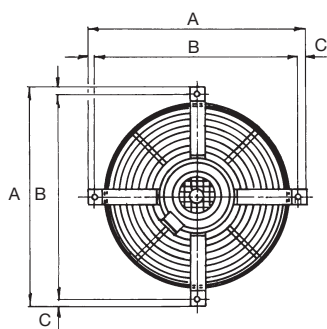
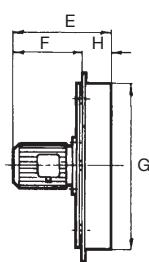
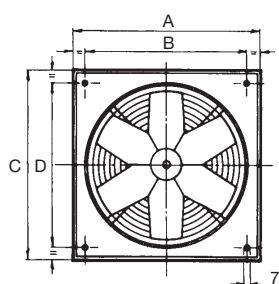

Anvendelse:

Enkel og prisbillig axial ventilator for montering på mur eller loft. Når ventilatoren monteres direkte til det fri, anbefales overtryksjalousi eller jalousirist med faste skråstillede lameller udvendig.

Udførelse:

CE / IP 55
Etilslutning: M 230V / T 400V / 50 Hz.
Motor: Vedligeholdelsesfri / Driftsikker
230 Volt - ventilatorerne kan hastighedsreguleres med 5 trins traforegulator, eller trinløs elektronisk. 254 M og 304 M kan leveres reversibel.

Vi står gerne til rådighed med forslag til Deres individuelle behov

Air-flow VENTILATION A/S

NYBROVEJ 65 • KØBENHAVN • 2820 GENTOFTE • TELEFON 45 88 16 88 • TELEFAX 45 88 25 07